

Modular Cooking Range Line EVO700 3 Drawer Refrigerated Base (R290)

ITEM # _____

MODEL # _____

NAME # _____

SIS # _____

AIA # _____



372292 (Z7TTAECOMKN)

Refrigerated base with 3
GN1/1 drawers, +10-2°C -
R290

Short Form Specification

Item No. _____

Built-in refrigerator compressor unit. Operating temperature range from -2°C to 10°C. To be installed below EVO700 top units. To be delivered with 50 mm height adjustable feet. Exterior panels in stainless steel with Scotch Brite finish. One piece pressed work top in 1.5 mm thick stainless steel. Right-angled side edges to allow flush-fitting junction between units.

Main Features

- Unit can be easily installed below other 700 line top models.
- Adjustable temperature range from -2 °C to +10 °C to suit meat, fish and dairy storage requirements.
- Anti-tilt runners accept GN 1/1 containers.
- Forced air circulation for rapid cooling and an even temperature distribution.
- Right angled side edges eliminate gaps and possible dirt traps between units.
- Defrosting and automatic evaporation of condense drain: the condense is automatically evaporated thanks to the electric resistance in the condense drain container.
- GN compliant.
- Designed for modular installation into the cooking block.

Construction

- Constructed in Stainless steel with Scotch Brite finish to meet the highest hygiene standards.
- Built-in compressor to suit operating conditions.
- Access to all components from the front.
- Unit delivered with 150 mm height adjustable feet in Stainless steel. Feet can be extended up to 250 mm.

Sustainability

- CFC and HCFC free (highly ecological refrigerant type: R290).

Optional Accessories

- Flanged feet kit PNC 206136
- Frontal kicking strip for concrete installation, 1600 mm PNC 206152
- Frontal kicking strip, 1600 mm PNC 206179
- 4 feet for concrete installation (not for 900 line freestanding grill) PNC 206210
- 2 panels for service duct (single installation) PNC 206248
- Pair of side kicking strips PNC 206249
- Pair of side kicking strips (concrete installation) PNC 206265
- 2 side covering panels, height 700 mm, depth 700 mm PNC 206319
- 2 drawers for refrigerated base PNC 206348
- Kit 6 wheels - 3 swivelling with brake PNC 206432

APPROVAL: _____

Modular Cooking Range Line EVO700 3 Drawer Refrigerated Base (R290)

Front

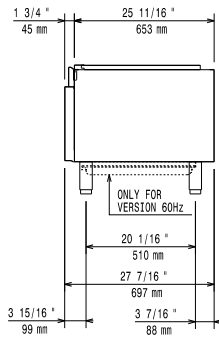

Side

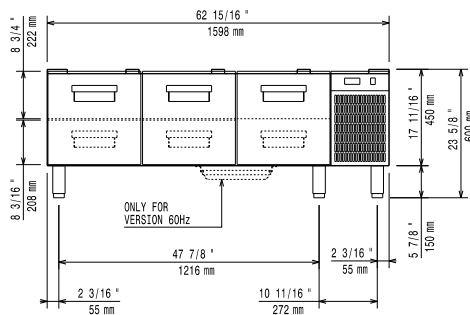

EI = Electrical inlet (power)

Top

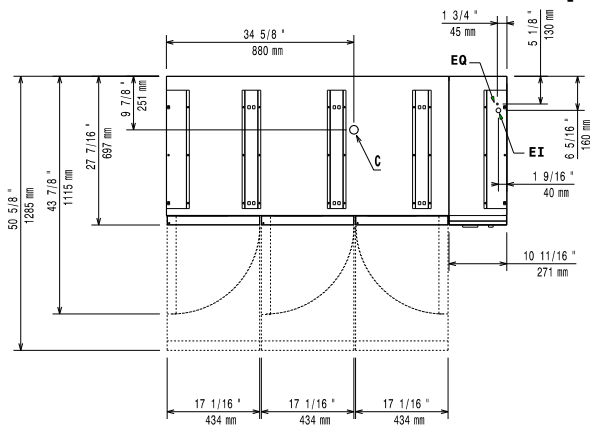

Electric

Supply voltage:	220-230 V/1N ph/50 Hz
Electrical power max.:	0.4 kW
Total Watts:	0.4 kW

Key Information:

External dimensions, Width:	1600 mm
External dimensions, Depth:	700 mm
External dimensions, Height:	600 mm
Net weight:	110 kg
Shipping weight:	124 kg
Shipping height:	780 mm
Shipping width:	820 mm
Shipping depth:	1650 mm
Shipping volume:	1.06 m ³
Gross capacity:	180 lt

Sustainability

Refrigerant type:	R290
Refrigerant weight:	85 g